

V O L V O



V O L V O

DIPLOMATIC
SALES

VOLVO EC40
FULLY ELECTRIC



p 3	Volvo EC40 Fully Electric offer
p 4-7	Designs
p 8-9	Standard equipment Core
p 10-11	Trim levels
p 12-13	Exterior
p 14-17	Interior
p 18	Wheels
p 19	Options
p 20	Option packs
p 21	Accessory packs
p 22-23	Accessories
p 24	Extended Services
p 25	Delivery Pack
p 26	Technical specifications
p 27	Volvo Care Offer

MADE BY
SWEDEN | BUILT IN
BELGIUM

VOLVO EC40 FULLY ELECTRIC OFFER

	Design	Motricity	Capacity hp/kW	Battery capacity nominal/usable kWh	Electric range up to km	Electric consumption kWh/100 km	Max power DC charging kW	List price € excl. VAT	List price € incl. VAT BE	List price € incl. VAT LU ⁽¹⁾
CORE										
Single Motor	Dark	RWD	238/175	70/67	487	16,7	180	44.586,78	53.950	52.167
Single Motor Extended Range	Dark	RWD	252/185	82/79	583	16,2	205	47.148,76	57.050	55.164
PLUS										
Single Motor	Dark	RWD	238/175	70/67	486	16,8	180	46.859,50	56.700	54.826
Single Motor	Black Edition	RWD	238/175	70/67	478	17,0	180	47.933,88	58.000	56.083
Single Motor Extended Range	Dark	RWD	252/185	82/79	582	16,3	205	49.421,49	59.800	57.823
Single Motor Extended Range	Black Edition	RWD	252/185	82/79	574	16,5	205	50.495,87	61.100	59.080
Twin Motor Performance	Dark	AWD	442/325	82/79	552	17,3	205	52.892,56	64.000	61.884
Twin Motor Performance	Black Edition	AWD	442/325	82/79	544	17,5	205	53.966,94	65.300	63.141
ULTRA										
Single Motor Extended Range	Dark	RWD	252/185	82/79	581	16,3	205	51.735,54	62.600	60.531
Single Motor Extended Range	Black Edition	RWD	252/185	82/79	573	16,5	205	52.809,92	63.900	61.788
Twin Motor Performance	Dark	AWD	442/325	82/79	551	17,3	205	55.206,61	66.800	64.592
Twin Motor Performance	Black Edition	AWD	442/325	82/79	543	17,6	205	56.280,99	68.100	65.849

Vehicles destined for EEA. The models listed above are destined for the European Economic Area ('EEA') market. Volvo Cars does not guarantee the compatibility of these models with any rules or regulations applicable outside the EEA. If you export these models outside of the EEA or if you request us to do so for you, such export will take place at your own risk.

Export of vehicles. Export outside of the country of purchase in any event occurs at your risk and cost. The prices listed above are exclusive of freight charges, taxes, licenses and any other documentation related to the export of your vehicle outside of the country of purchase. In case of export, the dealer will request you to deposit the amount of VAT applicable in the country of purchase as a guarantee. The dealer will reimburse the relevant amount to you upon receipt of (i) proof that you are exempted from VAT in the country where the vehicle is registered, or (ii) proof that VAT has been paid in the country where the vehicle is registered.

(1) Prices. A delivery fee of € 250 (excl. VAT) will be added to the prices listed above for vehicles supplied in the Grand Duchy of Luxembourg. The above-listed prices are furthermore exclusive of dealer preparation fees. Therefore, additional charges may be applied at your delivery point. Finally, you will be responsible for the payment of VAT (as applicable in the country of first registration of your vehicle) and any other taxes, as well as any registration and similar fees, all to the extent applicable. For ease of reference, VAT as currently applicable in Belgium and the Grand Duchy of Luxembourg are listed above.

**MAINTENANCE AND REPLACEMENT OF WEAR & TEAR PARTS*
5 YEARS OR 150.000 KM
(whichever comes first)**

**FACTORY WARRANTY ON YOUR VOLVO
3 YEARS OR 100.000 KM
(whichever comes first)**

FACTORY WARRANTY ON HIGH VOLTAGE BATTERY
8 YEARS OR 160.000 KM
(whichever comes first)**

* The **Volvo Care Offer 'Service & Maintenance for Volvo Fully Electric'** applies to the vehicle specified above, and for a period of **5 years from the date of delivery or 150.000 km** (whichever comes first). The Volvo Care Offer 'Service & Maintenance for Volvo Fully Electric' **covers periodic maintenance services, every 24 months or every 30.000 km** (whichever comes first), and **includes replacement of the wear and tear parts listed below.**

- Volvo Car Service at scheduled service intervals
- health check
- air filter replacement
- tyre sealant replacement in accordance with the prescribed interval
- cleaning of the sensors and cameras for the safety systems under the windscreen
- software updates
- **Includes** replacement of the following wear and tear parts: brake pads and discs (when required) and windscreen wiper blades (1x per year).
- **Excludes** replacement of wear and tear parts not explicitly mentioned above.

For more information about the Volvo Care Offer 'Service & Maintenance for Volvo Fully Electric', see page 27 of this price list.

** The batteries undergo normal wear depending on age and use. If the battery capacity falls below 70% of the original state within 8 years from the date of delivery or 160.000 km (whichever is reached first), the battery will be replaced under guarantee.



DESIGNS

DARK

For Core, Plus and Ultra

Front and rear bumpers with skidplates in Glossy Black

Covered grille with body coloured grille frame

Rear-view mirror caps in Black

High Gloss Black trim on lower part of side windows

19" 5 spoke alloy wheels Black/Diamond Cut



Images of an EC40 Ultra with optional equipment

DESIGNS



DESIGNS

BLACK EDITION

For Plus and Ultra

PLUS / ULTRA

Extra equipment in addition to Dark design:

	€ excl. VAT	€ incl. VAT BE	€ incl. VAT LU
Onyx Black Metallic (717)	739,67	895	865
Exclusive 20" alloy wheels with 5 spoke, in Black	801,65	970	938
Exclusive front Volvo logo in Glossy Black	206,61	250	242
Exclusive rear Volvo logo and badges in Glossy Black	206,61	250	242
TOTAL VALUE OF THE ADDITIONAL EQUIPMENT	1.954,55	2.365	2.287
ADVANTAGE BLACK EDITION	-880,17	-1.065	-1.030
PRICE SUPPLEMENT FOR BLACK EDITION versus DARK design*	1.074,38	1.300	1.257

*Supplement already included in the prices per trim level as shown on page 3.



Images of an EC40 Ultra Black Edition with optional tinted windows

DESIGNS



STANDARD EQUIPMENT EC40 CORE

CORE

Design	List price € excl. VAT	List price € incl. VAT BE	List price € incl. VAT LU	Single Motor	Single Motor Extended Range	Twin Motor Performance
Dark	0,00	0	0	S	S	-

S = Standard | - = Not available

SAFETY

Stability and traction control: Electronic Stability Control (ESC) including Active Yaw Control, Understeer Control Logic, Advanced Stability Control, Roll Stability Control, Driver Steering Recommendation, Dynamic Torque Vectoring, Trailer Stability Assist (only with the tow bar) and Hill Descent Control | Traction Control (TC) including Corner Traction Control with Torque Vectoring | Spin Control including Engine Drag Control

Advanced Driver Assist System (ADAS) sensor platform

Lane Keeping Aid: helps the driver to stay in lane (active from 65 km/h), including Run-off Road Mitigation: helps prevent the vehicle from running off the road, with steering aid and braking intervention (active between 65 and 140 km/h)

Oncoming Lane Mitigation: helps the driver to avoid collisions with vehicles coming in the opposite direction by automatically adjusting the steering

City Safety system: helps the driver to avoid or attenuate collisions with other vehicles (including those coming in the opposite direction at crossroads), cyclists, pedestrians (active up to a speed difference of 50 km/h, day and night), including active braking assistance

Driver Alert Control (DAC): system that detects and warns of tiredness

Connected Safety technology including Slippery Road Alert and Hazard Light Alert

Automatic braking after a collision

Indirect Tyre Pressure Monitoring System (iTTPMS)

Ultra-resistant structure of vehicle interior and roof in boron steel

Collapsible steering column

Automatic unlocking after a collision

Height-adjustable seat belts in front and with pre-tensioners and load limiters front and rear

Front airbags including driver's knee airbag, SIPS® side airbags and inflatable curtains

WHIPS® (Whiplash Injury Protection System): provides protection against injuries due to whiplash thanks to specific energy-absorbing backrests and seats and head restraints integrated into the front seats

Brake Pedal Release: automatic release of brake pedal, by means of a pyrotechnic device, in the event of an accident to attenuate injuries to feet, legs and back

Emergency brake lights

Power-operated child safety lock in rear doors

Isofix anchorages for the front passenger seat and the outer positions of the rear seat

Front passenger airbag cut-off switch

Acoustic Vehicle Alerting System (AVAS) at slow speed

DRIVER ASSISTANCE

Rear Park Assist Camera

Rear and Front Park Assist

Cruise control (not with Adaptive Cruise Control)

Intelligent Speed Assist (ISA)

Road Sign Information (RSI) : display of road sign information

Ready to Drive notification: function that informs the driver via a sound and a visual notification if the car is still standing still even though the vehicle in front has moved a certain distance or exceeded a certain speed

Drive Modes: 2 modes (Standard/Off-road) for Single Motor and Single Motor Extended Range

Drive Modes: 3 modes (Standard/Off-road/Performance) for Twin Motor Performance

MULTIMEDIA & CONNECTIVITY

New generation 12,3" driver information display with two new display modes : Calm and Nav

9" central touchscreen to control most of the functions

High Performance audio system with 8 speakers (1 full-range and 1 air woofer beneath the windscreen, 2 tweeters in front and 4 mid-range front and rear) and High Performance 250 W amplifier

Wireless charging for smartphone in the front storage compartment (electromagnetic induction technology)

Google infotainment system with :

- Google Maps: navigation and public charging stations locator

- Google Assistant: voice assistant via "Hey Google" to control certain car functions, navigation, your smartphone, media, search for online information or control certain connected devices

- Google Play Store: access to a catalog of in-car apps to download and use in the car (such as Spotify®, Waze®, Amazon Prime Video® and YouTube®)

4-year data subscription for use of Google services and all apps. After that period, a paid extension of the data subscription will be available or you can share your data via your smartphone

Remote functions via the Volvo Cars app on your smartphone, such as:

- launch and plan the preconditioning to cool/heat the cabin to comfort temperature and optimize your battery before departure

- (un)lock your car

- localize your car

- access to the Driving Journal

- plan and check the status of your electric charging session

Apple CarPlay® | Access to third developers apps

OTA: Over The Air updates for the car

DAB+ (Digital Audio Broadcasting)

2 USB-C connections at the front of the central console and two at the back

Controls integrated into steering wheel for driver display, cruise control, audio, phone, navigation system and voice commands

Integrated "SOS" button for assistance in life-threatening emergencies

Integrated "On Call" button for roadside assistance

Volvo Assistance | 3 years subscription included



**DARK
DESIGN**

STANDARD EQUIPMENT EC40 CORE

PERSONAL SAFETY AND CONVENIENCE

Convenient Entry and Start that among other things eliminates the need of a start button. When the driver is seated, the car starts as he presses the brake pedal and engages Drive or Reverse

Welcome lighting when the driver is approaching the car

One Pedal Drive: possibility to use only one pedal to accelerate or brake. Just by lifting the pedal the driver can, on a short distance, slow the car all the way to standstill not having to use the brake pedal

Electric parking brake with Auto Hold (automatic brake at a standstill) and Hill Start Assist (assistance to start on a hill or slope) functions

Immobiliser

One remote control and one "Care Key" which allows you to set a lower maximal speed (<180 km/h)

Tyre repair kit in the Frunk

CLIMATE CONTROL

Fixed panoramic sunroof with IR coating that minimises glare and gives effective UV protection

Two-zone electronic automatic climate control system with air vents at the rear, humidity sensor, air recirculation function and pollen filter

Clean Zone: IAQS (Interior Air Quality System) to improve air quality inside the vehicle, with active filter

Interior climate preconditioning (cabin cooling or heating)

Front wipers blades with integrated washers ("Aquablades")

Rain sensor with adjustable sensitivity level

VERSATILITY

Frunk: 31 liter front load compartment

Ticket holder on driver's side of the windscreen

Very spacious storage bins in front doors

Removable litter bin with lid in the central console

Folding hook in the glove compartment lid to hang small bags

Flat load floor with bench seat back folded down

Storage space beneath the luggage compartment floor

Rigid, detachable luggage cover, that can be stored beneath the luggage compartment floor

Storage pockets in backrest of front seats

Four shopping bag hooks and four folding load retainer eyelets in luggage compartment

INTERIOR

Comfort fronts seats with manual adjustable height and length and manual seat cushion extension

Textile City Canvas upholstery

Power-operated four-way lumbar support

Adjustable driver seat cushion incline

Rear seats with central armrest with cup holder, load hatch and folding back in two parts (60/40)

Aluminium front door sill moulding with EC40 logo

Charcoal central console at front with armrest, large storage compartment and two cup holders

Black finish on the central console and centre display trim and the front air vents

Charcoal Origin inlays in the dashboard and the front doors

Interior lighting Plus, including vanity mirrors with light at front, front and rear reading lights, dimmed lighting at front and floor lights at front

Black headlining

Inner rear-view mirror with automatic dimming

Black simili-leather steering wheel

Black simili-leather gear lever knob with Glossy Black inlay

Textile floor mats at front and rear in Charcoal

Aluminium load sill protection

EXTERIOR

LED headlights with integrated T-shaped daytime running lights, automatic level adjustment, Active High Beam and Volvo Safety Lights

Full LED rear lamps with lighting welcome sequence

19" 5 spoke Black/Diamond Cut alloy wheels

Dynamic chassis

16A 3-phase charging cable, Mode 3, with Mennekes socket (for charging point), length 6 m

11 kW onboard charger (AC-DC converter)

Wheel arches and lower bodywork parts in Matt Black plastic

Aerodynamic spoilers at the rear of the roof and at the tailgate

Power retractable heated outer rear-view mirrors with integrated LED indicator. With automatic dimming

Rear-view mirror caps in contrasting Solid Black (in Onyx Black with Onyx Black Metallic exterior colour)



TRIM LEVEL EC40 PLUS

PLUS

	Design	List price* € excl. VAT	List price* € incl. VAT BE	List price* € incl. VAT LU	Single Motor	Single Motor Extended Range	Twin Motor Performance
(Includes the EC40 Core equipment supplemented by the specific Plus equipment)	Dark	2.272,73	2.750	2.659	O	O	-
	Black Edition	3.347,11	4.050	3.916	O	O	-
	Dark	0,00	0	0	-	-	S
	Black Edition	1.074,38	1.300	1.257	-	-	O

*Supplement already included in the prices per trim level as shown in the table on page 3.

O = Option | S = Standard | - = Not available

Keyless Entry: passive (un)locking, hands-free tailgate opening/closing (foot movement under the rear bumper) and lighting in the door handles

Power-operated tailgate

Driver Assistance with:

- Adaptive Cruise Control: can help you keep a certain distance with the vehicle in front at all speeds
- Pilot Assist: enables empowered driving on motorways and roads with side ground marking up to a speed of 130 km/h
- Emergency Stop Assist: can bring the vehicle to a complete stop in lane in situations where the driver is not responding to hands-off warnings

Driver Awareness with:

- BLIS (Blind Spot Information System with steering assistance)
- Rear Collision Warning with automatic emergency braking
- Cross Traffic Alert: detection of vehicles coming from the side when reversing
- Prepared Front Safety Belts

Specific pedal response (Twin Motor Performance version)

Volvo Guard alarm with movement and inclination sensor and Private Locking for tailgate

Air purifier (incl. Advanced filter, AQS and PM 2.5 sensor) which removes up to 80% of all harmful PM 2.5 particles and pollen from the air in the car. Control and statistics via the central display or the Volvo Cars app

Multifunction folding load floor with shopping bag hook

Nylon safety net behind the front seats

DARK
DESIGN

OR

BLACK EDITION
DESIGN



TRIM LEVEL EC40 ULTRA

ULTRA

	Design	List price* € excl. VAT	List price* € incl. VAT BE	List price* € incl. VAT LU	Single Motor	Single Motor Extended Range	Twin Motor Performance
(Includes the C40 Plus equipment supplemented by the specific Ultra equipment)	Dark	4.586,78	5.550	5.367	–	O	–
	Black Edition	5.661,16	6.850	6.624	–	O	–
	Dark	2.314,05	2.800	2.707	–	–	O
	Black Edition	3.388,43	4.100	3.964	–	–	O

*Supplement already included in the prices per trim level as shown in the table on page 3.

O = Option | S = Standard | – = Not available

Harman Kardon audio system with 13 loud speakers (1 full-range and 1 air woofer beneath the windscreen, 2 tweeters, 4 mid-range, 2 woofers, 2 full-range surround and 1 ventilated subwoofer) and 660 W amplifier

360° Park Assist Camera with bird's-eye view

Rear, Front and Side Park Assist

Power-operated comfort fronts seats with memory function for driver seat position and external rear-view mirrors, and manual seat cushion extension

Power folding of the rear headrests











DARK
DESIGN

OR

BLACK EDITION
DESIGN



EXTERIOR

			List price € excl. VAT	List price € incl. VAT BE	List price € incl. VAT LU	CORE / PLUS / ULTRA	PLUS / ULTRA BLACK EDITION
SOLID PAINT							
	626	Cloud Blue	739,67	895	865	O	-
METALLIC PAINT							
	740	Vapour Grey Metallic	0,00	0	0	●	-
	707	Crystal White Pearl Metallic	739,67	895	865	O	-
	717	Onyx Black Metallic	0,00 739,67	0 895	0 865	- O	● -
	725	Fusion Red Metallic	739,67	895	865	O	-
	733	Sage Green Metallic	739,67	895	865	O	-
	734	Fjord Blue Metallic	739,67	895	865	O	-
	735	Silver Dawn Metallic	739,67	895	865	O	-
	743	Sand Dune Metallic	739,67	895	865	O	-

O = Option | ● = Included in trim level | - = Not available

EXTERIOR

	List price € excl. VAT	List price € incl. VAT BE	List price € incl. VAT LU	CORE	PLUS	ULTRA	PLUS / ULTRA BLACK EDITION
--	---------------------------	------------------------------	------------------------------	------	------	-------	-------------------------------

Colour coordinated roof

	0,00	0	0	●	●	–	●
--	------	---	---	---	---	---	---



Solid Black roof

	454,55	550	532	–	○	●	–
--	--------	-----	-----	---	---	---	---



INTERIOR

		List price € excl. VAT	List price € incl. VAT BE	List price € incl. VAT LU	CORE / PLUS / ULTRA	PLUS / ULTRA BLACK EDITION
COMFORT SEATS, TEXTILE CITY CANVAS						
R780	Interior base colour: Charcoal Colour seats: Charcoal Colour headlining: Charcoal Dashboard and front door inlays: Origin (Charcoal) Black simili-leather steering wheel with Silk Metal inlay Black finish on the central console	0,00	0	0	●	●
COMFORT SEATS, CONNECT NUBUCK TEXTILE/MICROTECH						
R980	Interior base colour: Charcoal Colour seats: Charcoal Colour headlining: Charcoal Colour dashboard and front door inlays: Topography, back-lit Black sport simili-leather steering wheel with Silk Metal inlay High Gloss Black finish on the central console Interior lighting Pro: includes among others vanity mirrors with light, front and rear reading lights, floor lights at front, load compartment lighting, dimmed lighting at front and rear	1.322,31	1.600	1.547	○	○
Y980*	Interior base colour: Charcoal/Fjord Blue Colour seats: Charcoal Colour headlining: Charcoal Colour dashboard and front door inlays: Topography, back-lit Colour carpets: Fjord Blue Black sport simili-leather steering wheel with Silk Metal inlay High Gloss Black finish on the central console Interior lighting Pro: includes among others vanity mirrors with light, front and rear reading lights, floor lights at front, load compartment lighting, dimmed lighting at front and rear	1.528,93	1.850	1.789	○	–

*Not with Fusion Red Metallic (725) and Sage Green Metallic (733) colours

○ = Option | ● = Included in trim level | – = Not available



R780



R980



Y980



Topography



INTERIOR

		List price € excl. VAT	List price € incl. VAT BE	List price € incl. VAT LU	CORE / PLUS / ULTRA	PLUS / ULTRA BLACK EDITION
COMFORT SEATS, MICROTECH/OPEN GRID TEXTILE						
RN80	Interior base colour: Charcoal Interior base colour: Charcoal Colour seats: Charcoal Colour headlining: Charcoal Dashboard and front door inlays: Topography, back-lit Black sport simili-leather steering wheel with Silk Metal inlay High Gloss Black finish on the central console Interior lighting Pro: includes among others vanity mirrors with light, front and rear reading lights, floor lights at front, load compartment lighting, dimmed lighting at front and rear	1.570,25	1.900	1.837	O	-
YN80	Interior base colour: Charcoal/Fjord Blue Colour seats: Charcoal Colour headlining: Charcoal Dashboard and front door inlays: Topography, back-lit Colour carpets: Fjord Blue Black sport simili-leather steering wheel with Silk Metal inlay High Gloss Black finish on the central console Interior lighting Pro: includes among others vanity mirrors with light, front and rear reading lights, floor lights at front, load compartment lighting, dimmed lighting at front and rear	1.570,25	1.900	1.837	O	-
RNDO	Interior base colour: Charcoal Colour seats: Dawn Colour headlining: Charcoal Dashboard and front door inlays: Driftwood Armrest: Dawn Black sport simili-leather steering wheel with Silk Metal inlay High Gloss Black finish on the central console Interior lighting Pro: includes among others vanity mirrors with light, front and rear reading lights, floor lights at front, load compartment lighting, dimmed lighting at front and rear	1.570,25	1.900	1.837	O	-
COMFORT SEATS, WOLMIX						
R8ZO	Interior base colour: Charcoal Steering wheel base colour: Charcoal Colour seats: Midnight Zink Colour headlining: Charcoal Dashboard and front door inlays: Topography, back-lit Crystal gearshifter Black sport simili-leather steering wheel with Silk Metal inlay High Gloss Black finish on the central console Interior lighting Pro: includes among others vanity mirrors with light, front and rear reading lights, floor lights at front, load compartment lighting, dimmed lighting at front and rear	1.900,83	2.300	2.224	O	-

O = Option | - = Not available



RN80



YN80







RND0



R8Z0



WHEELS

		List price € excl. VAT	List price € incl. VAT BE	List price € incl. VAT LU	CORE / PLUS / ULTRA	PLUS / ULTRA BLACK EDITION
19" ALLOY WHEELS						
	- 19" 5 spoke Black/Diamond Cut 235/50 R19 Front tyres 255/45 R19 Rear tyres	0,00	0	0	●	-
20" ALLOY WHEELS						
	1185 20" 5 spoke Glossy Black/Diamond Cut 235/45 R20 Front tyres 255/40 R20 Rear tyres	553,72	670	648	0	-
	- 20" 5-double spoke Black 235/45 R20 Front tyres 255/40 R20 Rear tyres	0,00	0	0	-	●
ALL-SEASON TYRES						
	1065 All-season tyres 19" replacing the standard tyres, exclusively available in combination with 19" wheels	206,61	250	242	0	-

0 = Option | ● = Included in trim level | - = Not available



OPTIONS

		List price € excl. VAT	List price € incl. VAT BE	List price € incl. VAT LU	CORE	PLUS	PLUS BLACK EDITION	ULTRA	ULTRA BLACK EDITION
DRIVER ASSISTANCE									
139	360° Park Assist Camera with bird's-eye view including Side Park Assist (only with Driver Assist Pack (P0005) with Core)	446,28	540	522	0	0	0	●	●
AUDIO									
1033	Harman Kardon audio system with 13 loud speakers (1 full-range and 1 air woofer beneath the windscreen, 2 tweeters, 4 mid-range, 2 woofers, 2 full-range surround and 1 ventilated subwoofer) and 660 W amplifier	553,72	670	648	–	0	0	●	●
EXTERIEUR									
160	Solid Black roof (not with Onyx Black Metallic)	454,55	550	532	–	0	–	●	–
179	Privacy glass for rear windows	330,58	400	387	0	0	0	0	0
VERSATILITY									
1028	Semi-automatic retractable tow bar with 13-pin outlet (Trailer Stability Assist system included)	950,41	1.150	1.112	0	0	0	0	0

0 = Option | ● = Included in trim level | – = Not available



OPTION PACKS

	List price € excl. VAT	List price € incl. VAT BE	List price € incl. VAT LU	CORE	PLUS / PLUS BLACK EDITION	ULTRA / ULTRA BLACK EDITION
LUXURY SEAT PACK						
47 Power-operated driver seat with memory function for seat position and outer rear-view mirrors	504,13	610	590			
10 Power-operated front passenger seat	355,37	430	416			
390 Power folding of the rear headrests	173,55	210	203			
Total value of equipment	1.033,06	1.250	1.209			
Diplo Pack advantage	-247,93	-300	-290			
P0001 LUXURY SEAT PACK	785,12	950	919	-	○	●
LIGHT PACK						
16 LED front fog lights	157,02	190	184			
65 High-pressure headlight washers	206,61	250	242			
1170 Full LED headlights with Pixel technology, integrated T-shaped daytime running lights and adaptive high beam: each contains 84 pixel LEDs that switches on and off independently to optimise the light pattern without dazzling the other road users	950,41	1.150	1.112			
Total value of equipment	1.314,05	1.590	1.537			
Diplo Pack advantage	-363,64	-440	-425			
P0004 LIGHT PACK	950,41	1.150	1.112	○	○	○
DRIVER ASSIST PACK						
132 Driver Assistance with: - Adaptive Cruise Control: can help you keep a certain distance with the vehicle in front at all speeds - Pilot Assist: enables empowered driving on motorways and roads with side ground marking up to a speed of 130 km/h - Emergency Stop Assist: can bring the vehicle to a complete stop in lane in situations where the driver is not responding to hands-off warnings	801,65	970	938			
603 Driver Awareness with: - BLIS (Blind Spot Information System with steering assistance) - Rear Collision Warning with automatic emergency braking - Cross Traffic Alert: detection of vehicles coming from the side when reversing - Prepared Front Safety Belts	454,55	550	532			
Total value of equipment	1.256,20	1.520	1.470			
Diplo Pack advantage	-305,79	-370	-358			
P0005 DRIVER ASSIST PACK	950,41	1.150	1.112	○	●	●
WINTER PACK						
11 Heated front seats	280,99	340	329			
869 Heated steering wheel	173,55	210	203			
1092 Heat pump	652,89	790	764			
Total value of equipment	1.107,44	1.340	1.296			
Diplo Pack advantage	-280,99	-340	-329			
P0008 WINTER PACK	826,45	1.000	967	○	○	○

○ = Option | ● = Included in trim level | - = Not available

ACCESSORY PACKS

	List price € excl. VAT	List price € incl. VAT BE	List price € incl. VAT LU	EC40
PROTECTION PACK				
A00112 Moulded plastic load compartment protection	128,10	155	150	
A00492 Rubber floor mat front and rear	119,83	145	140	
A00217 Anti-theft wheel locks	57,85	70	68	
Total value of equipment	305,79	370	358	
Diplo Pack advantage	-53,72	-65	-63	
PA001 PROTECTION PACK	252,07	305	295	O
TRAVEL PACK				
A00104 Aluminium transversal roof bars	252,07	305	295	
A01240 Roofbox 'Travel 400', glossy black (400L, 175x87x46 cm)	665,29	805	778	
Total value of equipment	917,36	1.110	1.073	
Diplo Pack advantage	-90,91	-110	-106	
PA002 TRAVEL PACK	826,45	1.000	967	O
CONVENIENCE PACK				
A00087 Glasses holder	49,59	60	58	
A00761 Wool neck cushion (Charcoal)	57,85	70	68	
A00106 Luggage net to be attached to load securing eyelets	57,85	70	68	
A01247 Charging cable storage bag	57,85	70	68	
A01437 Sunshade for panoramic roof	119,83	145	140	
Total value of equipment	342,98	415	401	
Diplo Pack advantage	-74,38	-90	-87	
PA003 CONVENIENCE PACK	268,60	325	314	O
KIDS PACK				
A00096 Kick guard with storage pockets	57,85	70	68	
A01507 Rearward facing child seat (for children from approx. 3 months to 4 years old)	516,53	625	604	
Total value of equipment	574,38	695	672	
Diplo Pack advantage	-53,72	-65	-63	
PA005 KIDS PACK	520,66	630	609	O

O = Option



ACCESSORIES

	List price € excl. VAT	List price € incl. VAT BE	List price € incl. VAT LU	EC40
RECHARGE				
A01230 Wallbox (until 22 kW) standard installation included*	1.938,02	2.345	2.267	0
A01150 Charging cord 1P 10A with Schuko socket (for domestic use), length 7 metres	363,64	440	425	0
A01354 Charging cord 3P 16A with CEE socket (for red industrial socket, 5 pins), length 6 metres	454,55	550	532	0
A01152 Charging cord 1P 16A with CEE socket (for blue industrial socket, 3 pins), length 7 metres	363,64	440	425	0
A01355 Charging cord 3P 16A mode 3 (type 2) with Mennekes socket (for charging point), length 6 metres	363,64	440	425	0
A01154 Charging cord 1P 16A mode 3 (type 2) with Mennekes socket (for charging point), length 7 metres	363,64	440	425	0
A01247 Charging cable storage bag	57,85	70	68	0
LUGGAGE COMPARTMENT				
A00112 Moulded plastic load compartment protection	128,10	155	150	0
A00382 Textile/plastic reversible load compartment floor mat	181,82	220	213	0
A00106 Luggage net to be attached to load securing eyelets	57,85	70	68	0
A00210 Nylon safety net behind the front seats	128,10	155	150	0
DESIGN				
A00594 Illuminated tailgate scuff plate, Charcoal	413,22	500	483	0
VERSATILITY				
A00463** Preparation for mounting tow bar as accessory	0,00	0	0	0
Semi-automatic retractable tow bar with 13-pin outlet (Trailer Stability Assist system included)	950,41	1.150	1.112	0
A01238 Folding bicycle holder on tow bar for two bicycles (Fix4Bike)	685,95	830	803	0
A01239 Bicycle holder on tow bar for three bicycles (Fix4Bike)	710,74	860	832	0
A00017 Adapter for extra bike (only with A01239)	128,10	155	150	0
A00101 Aluminium transversal roof bars	252,07	305	295	0
A01240 Roofbox 'Travel 400', glossy black (400L, 175x87x46 cm)	665,29	805	778	0
A01241 Roofbox 'Travel Active 500', glossy black (500L, 215x92x44 cm)	756,20	915	885	0
A01399 Roofbox 'Travel Premier 430', glossy black (430L, 223x94x30 cm), with LED lighting	962,81	1.165	1.126	0
A00221 Ski holder, (4 pairs of skis) to mount on roof bars	161,16	195	189	0
A00219 Ski holder, (6 pairs of skis) to mount on roof bars	210,74	255	247	0
A01143 Ski holder, sliding, to be fitted on load carrier	185,95	225	218	0
A00025 Bicycle holder with frame bracket (aluminium), to be fitted on load carrier (1 bicycle)	128,10	155	150	0
A00111 Lock kit - one key system	57,85	70	68	0

* Indicative pricing for charging station with 1 fixed cable of 5m or socket and loadbalancing module. A standard installation includes an installation check by phone, wall or pole mounted (max 1 meter ground works), circuit breaker, fuses, 10m cable, 10m data cable, 10m tube, if necessary a supplementary small electricity cabinet, explanation, electric scheme, legal control. No demolition or excavation works included. Final price through tailor-made offer based on onsite visit.

** Accessories that affect the weight and aerodynamics of the car, and therefore also the electricity consumption and the range measured according to the WLTP.

O = Option



ACCESSORIES

		List price € excl. VAT	List price € incl. VAT BE	List price € incl. VAT LU	EC40
COMFORT					
A00492	Rubber floor mat front and rear	119,83	145	140	0
A00744	Windscreen sunshade	119,83	145	140	0
A00087	Glasses holder	49,59	60	58	0
A00530	Ashtray	37,19	45	44	0
A00761	Wool neck cushion (Charcoal)	57,85	70	68	0
A00763	Nubuck neck cushion (Blond)	57,85	70	68	0
A00769	Wool cushion (Charcoal)	57,85	70	68	0
A01237	Tablet holder	231,40	280	271	0
A01437	Sunshade for panoramic roof	119,83	145	140	0
CHILD SAFETY					
A00096	Kick guard with storage pockets	57,85	70	68	0
A01000	Easy access rearward facing child seat i-Size with Isofix (0-18 kg)	628,10	760	735	0
A00379	Booster seat with detachable backrest in wool (15-36 kg)	231,40	280	271	0
A00329	Child seat group 2/3 (15-36 kg) with Isofix anchorage	301,65	365	353	0
A01507	Rearward facing child seat (for children from approx. 3 months to 4 years old)	516,53	625	604	0
SECURITY & PROTECTION					
A01251	Mini remote control 'Sport Key'	181,82	220	213	0
A00604	Dog harness	119,83	145	140	0
A00217	Anti-theft wheel locks	57,85	70	68	0
A00164**	Front mud flaps	78,51	95	92	0
A00165**	Rear mud flaps	78,51	95	92	0
A00228	AutoSock (snow socks)	107,44	130	126	0
A00227	Centrax snow chains (for 19" and 20" wheels)	342,98	415	401	0
A01250	Dashcam front	247,93	300	290	0
A01497	Dashcam front and rear	433,88	525	508	0
A01327	Digital rearview mirror	739,67	895	865	0
WHEELS					
A01311	Winter wheels with 19" 5-double-spoke Black Diamond Cut rims and 235/50 R19 - 255/45 R19 winter tyres	2.388,43	2.890	2.794	0
A01312	Winter wheels with 20" 5-spoke Black Diamond Cut rims and 235/45 R20 - 255/40 R20 winter tyres	2.735,54	3.310	3.201	0

** Accessories that affect the weight and aerodynamics of the car, and therefore also the electricity consumption and the range measured according to the WLTP.

O = Option



EXTENDED SERVICES

VOLVO CAR EXTENDED WARRANTY

Drive with **peace of mind**

When you buy a Volvo, you are choosing top quality, safety and reliability. Not only because you are buying a quality vehicle, but also because your Volvo dealer offers you the best service.

An extension of the factory guarantee protects you against high costs in the event of unexpected defects. Thanks to the very comprehensive coverage, you can drive your Volvo for an additional 2 years without any worries when your Volvo manufacturer's warranty expires after 3 years.

Volvo Car Extended Warranty protects you against unforeseen repair costs, even after the Volvo manufacturer's warranty has expired.



GUARANTEED LIQUIDITY IN CASE OF REPAIRS

And extensive repair costs reimbursement outside the manufacturer's warranty

VALID ANYWHERE IN EUROPE

The extended warranty can also be transferred to the next owner

USE OF GENUINE VOLVO PARTS

And repaired by Volvo-trained personnel: your Volvo remains in optimal condition

	List price € excl. VAT	List price € incl. VAT BE	List price € incl. VAT LU	EC40
EXTENDED WARRANTY				
A00139 Volvo Car Extended Warranty + 1 year, limited to 200.000 km	371,90	450	435	O
A00140 Volvo Car Extended Warranty + 2 years, limited to 200.000 km	739,67	895	865	O

O = Option

DELIVERY PACK

VOLVO CAR DELIVERY PACK

Enjoy a **personalized delivery**

The delivery of a new car is a special moment. And Volvo makes this moment even more special. With the Delivery Pack, we provide a personalized unveiling of your new Volvo followed by a detailed explanation during and after delivery. Of course, we make sure your car is fully roadworthy and equipped to enjoy the Volvo experience right away.



- 5 safety vests
- fire extinguisher
- warning triangle
- front numberplate

- car charged to at least 80%
- detailed explanation of all car features
- Volvo Cars app setup

- car delivered under cover with personalized nameplate
- 1 hour follow-up meeting for all your questions after delivery

	List price € excl. VAT	List price € incl. VAT BE	List price € incl. VAT LU
DELIVERY PACK			
DELIV01 Volvo Car Delivery Pack	371,90	450	435

TECHNICAL SPECIFICATIONS

ENGINE	Single Motor	Single Motor Extended Range	Twin Motor Performance
Engine code	E400V23 (EB)	E400V8 (EH)	E400V19 (EY)
Engine type	One electric motor	One electric motor	Two electric motors
Electric engine battery	Lithium-ion	Lithium-ion	Lithium-ion
Battery energy capacity (nominal) kWh	70	82	82
Battery energy capacity (usable) kWh	67	79	79
Max. capacity kW/hp (rear engine)	175/238	185/252	190/258
Max. capacity kW/hp (front engine)	-	-	135/184
Max. torque Nm (rear engine)	420	420	420
Max. torque Nm (front engine)	-	-	250
Emissions standard	EURO 6e	EURO 6e	EURO 6e
TRANSMISSION			
Motricity	RWD	RWD	AWD
Gearbox	Single-speed	Single-speed	Single-speed
PERFORMANCES			
Acceleration 0-100 km/h (sec)	7,3	7,3	4,6
Top speed (km/h)	180	180	180
RECHARGE			
Max AC charging (kW)	11	11	11
Max DC charging (kW)	180	205	205
Charge time, 1-phase, AC, from 0 to 100% (32A/16A/10A) 230V (hours)	10/20/33	13/25/42	13/25/42
Charge time, 3-phase, AC, from 0 to 100% (16A/10A) (hours)	7/11	8/15	8/15
Charge time, DC, from 10 to 80% (200 kW/150 kW/50 kW fast charger) (min.)	26/27/61	28/29/68	28/29/68
CONSUMPTION AND RANGE ACCORDING TO WLTP			
Electric power consumption (combined) kWh/100km	16,7-17,4	16,2-16,9	17,3-17,9
Electric range (combined) km	487-445	583-540	552-510
WEIGHTS AND MEASURES			
Min. curb weight (kg)	1.977	2.021	2.110
Running order weight (kg)	2.065	2.095	2.185
Max. total weight (kg)	2.460	2.500	2.620
Max. weight braked/unbraked trailer (kg)	1.500/750	1.500/750	1.800/750
Max. roof load capacity (kg)	75	75	75
Largest load volume with bench seat back folded down ISO V214-1 (incl. V209) (liters)	1.196	1.196	1.196
Largest volume load compartment ISO V214-2 (incl. V209) (liters)	480	480	480
Volume load compartment under luggage cover ISO V211-2 (incl. V209) (liters)	404	404	404
Volume under load compartment floor ISO V209 (liters)	59	59	59

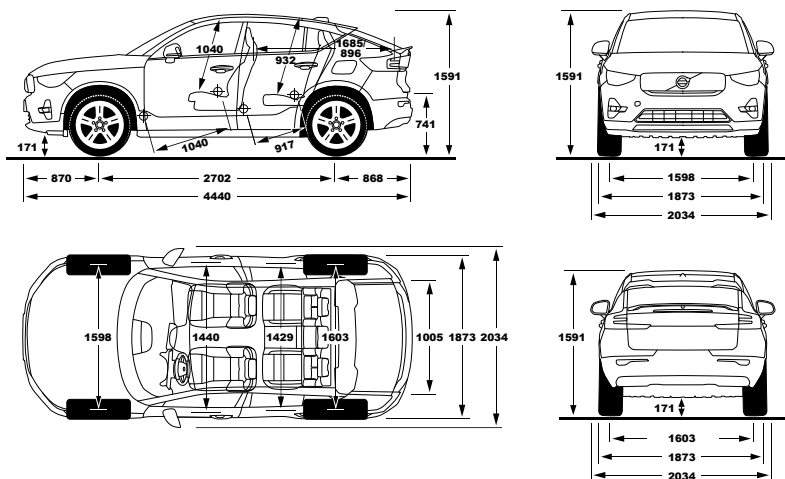

DIMENSIONS

EXTERIOR

Length x width x height (driver included)	444,0 x 187,3 x 159,6 cm
Wheelbase	270,2 cm
Front track (19" rims / 20" rims)	159,8/160,1 cm
Rear track (19" rims / 20" rims)	160,3/160,8 cm
Turning circle between curbs	11,4 m
Ground clearance (driver included)/fording depth	17,1/45,0 cm

INTERIOR

Headroom with sunroof front/rear	100,2/93,2 cm
Shoulder room front/rear	144,0/142,9 cm
Leg room front/rear	104,0/91,7 cm
Length luggage compartment rear seats-tailgate	89,6 cm
Length luggage compartment front seats-tailgate	168,5 cm
Height luggage compartment	62,9 cm
Lifting height	74,1 cm
Width luggage compartment between wheel arches	100,5 cm
Min./max. width tailgate opening	102,2/105,9 cm

VOLVO CARE OFFER FOR VOLVO FULLY ELECTRIC

The Volvo Care Offer 'Service & Maintenance for Volvo Fully Electric' is included* with the purchase of any new, all-electric Volvo. This page describes the services and parts included in the maintenance and service programme for these vehicles.

The Volvo Care Offer 'Service & Maintenance for Volvo Fully Electric' is valid for a period of **5 years from the date of delivery or 150.000 km** (whichever comes first). The vehicle owner can have the periodic maintenance of his/her Volvo Fully Electric carried out at the prescribed service intervals in any authorised Volvo workshop in Belgium or the Grand Duchy of Luxembourg.

Our in-house trained Volvo technicians maintain the vehicle and keep it in top condition. They also carry out a health check and verify whether the vehicle is equipped with the latest software.

The detailed terms and conditions applicable to this Volvo Care Offer 'Service & Maintenance for Volvo Fully Electric', including restrictions, will be handed over to the first owner of the vehicle by the Volvo retailer who delivers the vehicle. These will remain valid for the stated duration and mileage, even if there has been a change in ownership.

The Volvo Care Offer 'Service & Maintenance for Volvo Fully Electric' applies to the vehicle specified on page 3 in this price list, and for a period of **5 years from the date of delivery or 150.000 km** (whichever comes first). The Volvo Care Offer 'Service & Maintenance for Volvo Fully Electric' covers periodic maintenance services, every 24 months or every 30.000 km (whichever comes first), and includes replacement of the wear and tear parts listed below.

- Volvo Car Service at scheduled service intervals
 - health check
 - air filter replacement
 - tyre sealant replacement in accordance with the prescribed interval
 - cleaning of the sensors and cameras for the safety systems under the windscreen
 - software updates
- **Includes** replacement of the following wear and tear parts: brake pads and discs (when required) and windscreen wiper blades (1x per year).
 - **Excludes** replacement of wear and tear parts not explicitly mentioned above.

* Volvo vehicles with specific service programmes (such as taxis, police vehicles or vehicles with other specific purposes) are not eligible for the Volvo Care Offer 'Service & Maintenance for Volvo Fully Electric' described above.

The 'Volvo Car Service' maintenance programme may be amended by Volvo Cars, provided that such amendment will not affect the application of the Volvo Cars warranty or affect the vehicle owner's rights under the Volvo Care Offer.

The inclusion of wear and tear parts in the Volvo Care Offer 'Service & Maintenance for Volvo Fully Electric' does not affect the reference to 'wear and tear' in the Service and Warranty Booklet.

The Volvo Care Offer 'Service & Maintenance for Volvo Fully Electric' is subject to the terms and conditions regarding service and maintenance. Should you have any questions about this, please do not hesitate to contact our Volvo retailers.

VOLVO CARE OFFER GENERAL TERMS AND CONDITIONS 'SERVICE & MAINTENANCE FOR VOLVO FULLY ELECTRIC'

1. Application of the conditions

These Volvo Care Offer terms and conditions 'Service & Maintenance for Volvo Fully Electric' apply to new, all-electric Volvo vehicles. These terms and conditions form part of the purchase contract for the vehicle. Regardless of whether the vehicle is purchased from a Volvo Car Corporation entity or from a Volvo retailer, the Volvo National Sales Company or Volvo's importer in the country of first purchase is responsible for this service programme.

2. Validity of the Volvo Care Offer 'Service & Maintenance for Volvo Fully Electric'

- a) The Volvo Care Offer 'Service & Maintenance for Volvo Fully Electric' is valid for a defined limited period of time, as previously stated and includes, where applicable, defined wear and tear parts of the vehicle, as previously specified. Any work carried out that is not covered by the Volvo Care Offer 'Service & Maintenance for Volvo Fully Electric' will remain the responsibility of the customer. When all required work has been carried out or when the limited validity period has expired, the Volvo Care Offer 'Service & Maintenance for Volvo Fully Electric' will end. The maintenance programme will also be considered terminated if maintenance should have been carried out in accordance with the prescribed maintenance intervals (as stated in the owner's manual and the Service and Warranty Booklet for the vehicle) but the vehicle has not been presented to an authorised Volvo workshop to carry out the Volvo Car Service.
- b) The Volvo Care Offer 'Service & Maintenance for Volvo Fully Electric' is linked to the market in which it was originally sold. The periodic maintenance of the vehicle according to the prescribed service intervals can only be carried out in the authorised Volvo workshops within that market.
- c) Volvo Cars has the right to terminate the Volvo Care Offer 'Service & Maintenance for Volvo Fully Electric' with immediate effect should the conditions of Volvo Cars' operations in the relevant market change significantly due to circumstances outside of Volvo Cars' control and should these circumstances make it very difficult for Volvo Cars to carry out the Volvo Care Offer 'Service & Maintenance for Volvo Fully Electric'. Both parties have the right to terminate the Volvo Care Offer 'Service & Maintenance for Volvo Fully Electric' with immediate effect should the other party be in serious or repeated breach of its obligations under these terms and conditions.

3. Owner obligations

Periodic maintenance of the vehicle must be carried out according to Volvo Cars' recommendations. Volvo Car Service in accordance with the prescribed service

intervals, depends on time and annual mileage and may occur at different time intervals. The validity of the Volvo Care Offer 'Service & Maintenance for Volvo Fully Electric' further requires that the vehicle owner:

- Drives, maintains and manages the vehicle in accordance with the instructions in the vehicle owner's manual (extended version can be found at volvocars.com) and in the Service and Warranty Booklet (included in the vehicle documents).
- Conducts routine checks of the fluid levels in the vehicle between recommended service intervals and, if necessary, fills up at its own expense.
- Delivers the vehicle, at its own expense, to an authorised Volvo workshop for maintenance in accordance with the service intervals specified in the owner's manual and the vehicle Service and Warranty Booklet.

4. Transfer of the Volvo Care Offer 'Service & Maintenance for Volvo Fully Electric'

If the vehicle is sold or otherwise transferred to a new owner, the Volvo Care Offer 'Service & Maintenance for Volvo Fully Electric' follows the vehicle. All remaining services in the maintenance programme can then be used by the new owner in accordance with these terms and conditions.

5. Disclaimer

This maintenance programme Volvo Care Offer 'Service & Maintenance for Volvo Fully Electric' does not include any obligation on the part of any Volvo retailer or Volvo Cars to reimburse the vehicle owner in any way for costs, loss of income, loss of time or any other damage caused by the vehicle being temporarily handed over to the workshop for maintenance, or by the vehicle not being able to be used during the period in which it has been handed over to the workshop for scheduled maintenance. Nothing in these terms and conditions shall exclude, limit or modify any warranty, guarantee, term or condition, right or remedy implied or imposed by applicable law which cannot be legally excluded or limited.

6. Applicable Laws and Disputes

In the event of any dispute concerning the interpretation or application of the Volvo Care Offer 'Service & Maintenance for Volvo Fully Electric', the parties shall seek to resolve this by mutual agreement. The Volvo Care Offer 'Service & Maintenance for Volvo Fully Electric' shall be governed by the laws of the country of first purchase of the vehicle and in the event of any dispute the competent national courts shall have jurisdiction.



Some of the information in this brochure may be incorrect due to changes to the product specifications introduced after the brochure was published, such as consumption figures. Volvo Car Belux reserves the right to make changes to the prices, colours, materials, specifications and models at any time without prior notice. The images shown are for information purposes only and may differ from the actual product. Certain equipment, options or accessories described or shown are available at an additional cost. All list prices in this brochure are recommended resale prices. VAT applicable is 21% for Belgium and 17% for the Grand Duchy of Luxembourg. Ask your Volvo distributor for the latest information before ordering.

The prices for accessories always include fitting (unless otherwise specified) and (where applicable) Recupel (for Belgium) or Ecotrel (for Grand Duchy of Luxembourg). Recommended prices for winter wheel kits (composed of 4 complete winter wheels with rims and tyres) always include environmental contribution (Recytyre for Belgium), but without fitting and software update (if needed).

Environmental contribution included.

A 4-year data subscription for use of Google services and all apps is included in the retail price of the car. After that period, a paid extension of the data subscription will be available or you can share your data via your smartphone.

Environmental information [Royal Decree 19/03/2004]: all self-respecting Volvo drivers put safety first.
R.P.: Florent Andrieu - Registered address/head office: Volvo Car Belgium nv, Avenue John Kennedy 25, B-9000 Ghent - Place of business: Volvo Car Belux - VAT no.: BE 0420.383.548

V O L V O

VOLVOCARS.BE/LU
2024 - V02.MY25

