

V O L V O



V O L V O

DIPLOMATIC
SALES

30 April 2024 - Recommended prices Model year 2025

THE NEW
VOLVO EX30
FULLY ELECTRIC

[VOLVOCARS.BE/.LU](https://www.volvocars.be/.lu)



p 3	Volvo EX30 Fully Electric offer
p 4-7	Standard equipment Core
p 8	Trim levels
p 10-13	Interior
p 14-15	Exterior
p 16	Tinted windows
p 16	Wheels
p 18	Option packs
p 18	Accessory packs & accessories
p 19-21	Accessories
p 22	Extended Services
p 23	Delivery Pack
p 24	Technical specifications
p 25	Volvo Care Offer

MADE BY | **SWEDEN**

VOLVO EX30 FULLY ELECTRIC OFFER

	Motricity	Capacity hp/kW	Battery energy capacity nominal/usable kWh	Electric range until km	Electric consumption kWh/100 km	Maximum power DC charging kW	List price € excl. VAT	List price € incl. VAT BE	List price € incl. VAT LU ⁽¹⁾
VOLVO EX30									
CORE									
Single Motor	RWD	272/200	51/49	337	17,1	134	32.223,14	38.990	37.701
Single Motor Extended Range	RWD	272/200	69/65	475	17,0	153	36.578,51	44.260	42.797
PLUS									
Single Motor	RWD	272/200	51/49	337	17,1	134	34.677,69	41.960	40.573
Single Motor Extended Range	RWD	272/200	69/65	476	17,0	153	39.512,40	47.810	46.230
Twin Motor Performance	AWD	428/315	69/65	450	17,5	153	41.743,80	50.510	48.840
ULTRA									
Single Motor Extended Range	RWD	272/200	69/65	475	17,0	153	42.115,70	50.960	49.275
Twin Motor Performance	AWD	428/315	69/65	450	17,5	153	44.347,11	53.660	51.886

Vehicles destined for EEA. The models listed above are destined for the European Economic Area ('EEA') market. Volvo Cars does not guarantee the compatibility of these models with any rules or regulations applicable outside the EEA. If you export these models outside of the EEA or if you request us to do so for you, such export will take place at your own risk.

Export of vehicles. Export outside of the country of purchase in any event occurs at your risk and cost. The prices listed above are exclusive of freight charges, taxes, licenses and any other documentation related to the export of your vehicle outside of the country of purchase. In case of export, the dealer will request you to deposit the amount of VAT applicable in the country of purchase as a guarantee. The dealer will reimburse the relevant amount to you upon receipt of (i) proof that you are exempted from VAT in the country where the vehicle is registered, or (ii) proof that VAT has been paid in the country where the vehicle is registered.

(1) Prices. A delivery fee of € 250 (excl. VAT) will be added to the prices listed above for vehicles supplied in the Grand Duchy of Luxembourg. The above-listed prices are furthermore exclusive of dealer preparation fees. Therefore, additional charges may be applied at your delivery point. Finally, you will be responsible for the payment of VAT (as applicable in the country of first registration of your vehicle) and any other taxes, as well as any registration and similar fees, all to the extent applicable. For ease of reference, VAT as currently applicable in Belgium and the Grand Duchy of Luxembourg are listed above.

**MAINTENANCE AND
REPLACEMENT OF
WEAR & TEAR PARTS***
5 YEARS OR 150.000 KM
(whichever comes first)

**FACTORY WARRANTY
ON YOUR VOLVO**
3 YEARS OR 100.000 KM
(whichever comes first)

**FACTORY WARRANTY
ON HIGH VOLTAGE
BATTERY****
8 YEARS OR 160.000 KM
(whichever comes first)

* The **Volvo Care Offer 'Service & Maintenance for Volvo Fully Electric'** applies to the vehicle specified above, and for a period of **5 years from the date of delivery or 150.000 km** (whichever comes first). The Volvo Care Offer 'Service & Maintenance for Volvo Fully Electric' **covers periodic maintenance services, every 24 months or every 30.000 km** (whichever comes first), **and includes replacement of the wear and tear parts listed below.**

- Volvo Car Service at scheduled service intervals
- health check
- air filter replacement
- tyre sealant replacement in accordance with the prescribed interval
- cleaning of the sensors and cameras for the safety systems under the windscreen
- software updates
- **Includes** replacement of the following wear and tear parts: brake pads and discs (when required) and windscreen wiper blades (1x per year).
- **Excludes** replacement of wear and tear parts not explicitly mentioned above.

For more information about the Volvo Care Offer 'Service & Maintenance for Volvo Fully Electric', see page 25 of this price list.

** The batteries undergo normal wear depending on age and use. If the battery capacity falls below 70% of the original state within 8 years from the date of delivery or 160.000 km (whichever is reached first), the battery will be replaced under guarantee.



STANDARD EQUIPMENT CORE

CORE	List price € excl. VAT	List price € incl. VAT BE	List price € incl. VAT LU	Single Motor	Single Motor Extended Range	Twin Motor Performance
	0,00	0	0	S	S	-

S = Standard | - = Not available

SAFE SPACE TECHNOLOGY

Advanced radar and camera platform: 5 radars, 1 in each corner of the car and 1 in the front bumper, as well as 1 front camera

Advanced safety alert and intervention system, including:

- Blind Spot Information System with steering assistance (BLIS)
- Door opening alert when cars, pedestrians, cyclists scooters or motorcycles approach from behind
- Rear Collision Warning with rear hazard warning lights activation, and automatic emergency braking if the car is at a standstill
- Front and Rear Cross Traffic Alert: detection of vehicles coming from the side when driving forward or reversing

Intersection Autobrake function that can intervene if there is a risk of collision. When the driver is about to make a left turn in an intersection with oncoming traffic, the car can brake automatically to help avoid an impact. This function can also support in straight crossings with traffic coming from the sides

Collision Avoidance & Mitigation by Braking and Steering: the car's radars and front camera keep a constant track on vehicles, motorcycles, scooters, pedestrians, and cyclists ahead. If there's a risk of collision, the car is designed to first alert the driver. If necessary, it can brake automatically or even apply slight steering assistance to enhance an already initiated manoeuvre by the driver

Oncoming Lane Mitigation: helps the driver to avoid collisions with vehicles coming in the opposite direction by automatically adjusting the steering (active between 60 and 140 km/h) & Oncoming Mitigation by Braking: automatic braking system attenuating the impact of a head-on collision

Vehicle, Cyclist and Pedestrian Detection: thanks to the radar and camera platform, the car can detect moving as well as stationary cars, trucks and buses, but also motorcycles, scooters, pedestrians and cyclists

Pedestrian, Cyclist and Scooter Steering Avoidance: on a rural road without pavement and with clearly visible road marks, when you catch up a cyclist, pedestrian or a scooter travelling in the same direction as you but haven't spotted it immediately, this new function can help you avoid a collision. If the car senses a collision is likely to happen, it can actively take over the steering and steer away as long as you don't cross the lane markings. After having passed the road user with a sufficient safety distance, the car regains its position on the road

Lane Keeping Aid: helps the driver to stay in lane (active from 65 km/h), including Run-off Road Mitigation: helps prevent the vehicle from running off the road, with steering aid and braking intervention (active between 60 and 140 km/h)

SAFETY

Stability and traction control: Electronic Stability Control (ESC) including Active Yaw Control, Advanced Stability Control, Trailer Stability Assist (only with the tow bar) and Hill Descent Control | Traction Control (TC) including Corner Traction Control with Torque Vectoring | Spin Control

Automatic braking after a collision

Tyre Pressure Monitoring System (TPMS)

Ultra-resistant structure of vehicle interior and roof

Collapsible steering column

Automatic unlocking after a collision

Height-adjustable seat belts in front and with pre-tensioners and load limiters front and rear

Front airbags including a far side airbag mounted inside the driver seat, SIPS® side airbags and inflatable curtains

Front passenger airbag cut-off switch

WHIPS® (Whiplash Injury Protection System): provides protection against injuries due to whiplash thanks to specific energy-absorbing backrests and seats and head restraints integrated into the front seats

Emergency brake lights

Rear doors manual child safety lock

Isofix anchorages for the outer positions of the rear seat

Acoustic Vehicle Alerting System (AVAS) at slow speed



STANDARD EQUIPMENT CORE

MULTIMEDIA & CONNECTIVITY

12,3" central touchscreen divided into different parts with the highest part showing the most important driver information

Google infotainment system with :

- Google Maps: navigation and public charging stations locator
 - Google Assistant: voice assistant via "Hey Google" to control certain car functions, navigation, your smartphone, media, search for online information or control certain connected devices
 - Google Play Store: access to a catalog of in-car apps to download and use in the car (such as Spotify®, Waze®, Amazon Prime Video® and YouTube®)
-

4-year data subscription for use of Google services and all apps. After that period, a paid extension of the data subscription will be available or you can share your data via your smartphone

Remote functions via the Volvo EX30 app on your smartphone, such as:

- launch and plan the preconditioning to cool/heat the cabin to comfort temperature and optimize your battery before departure
 - (un)lock your car
 - localize your car
 - access to the Driving Journal
 - plan and check the status of your electric charging session
-

Wireless smartphone integration (Apple CarPlay®) | Access to third developers apps such as Waze and WhatsApp® (available in the course of 2024)

5G capabilities

OTA: Over The Air updates for the car

High Performance audio system with 5 speakers and 100W 4 channel amplifier

- 2 soft dome tweeters and 2 midrange integrated in a soundbar under the windscreen
 - 1 air ventilated woofer under the windscreen
-

DAB+ (Digital Audio Broadcasting)

2 front USB-C outlets

Integrated "SOS" button for assistance in life-threatening emergencies

Integrated "On Call" button for roadside assistance

Volvo Assistance | 3 years subscription included

DRIVER ASSISTANCE

Rear Park Assist Camera and Park Assist

Adaptive Cruise Control that can support you up to 150km/h, including:

- Cruise Control: when no vehicle is in front of the vehicle, it can control the vehicle to the set speed
 - Follow Cruise: follow the vehicle in front with a certain distance according to the time gap you set
 - Overtake Assist: when you engage the turn indicator and control the vehicle to go into the overtaking lane, it will accelerate to the set speed if no vehicle is in front of you
 - Stop & Go: decelerates to a standstill if the vehicle in front stops and then automatically drives off and resumes speed to follow the vehicle in front
 - Intelligent Speed Assist (ISA) : set automatically the Road limitation speed (detected by the RSI) as the setting speed when driving on a road where the speed limit is decreasing
-

Road Sign Information (RSI): display of road sign information with excess speed warning utilizing the front camera and map-based information

Automatic Speed Limiter: when Pilot Assist or Adaptive Cruise Control is activated, it can adjust your speed according to the current road speed limits

Driver Alert System: detects and warns of tiredness (from 30 km/h) thanks to a camera behind the steering wheel that tracks eye and face movements



STANDARD EQUIPMENT CORE

PERSONAL SAFETY AND CONVENIENCE

Volvo Guard alarm with movement and inclination sensor

Interior lighting including:

- front doorpanel insert light
 - tunnel light in the open storage between the console armrest and lower instrument panel
 - front and rear cabin and reading lights in the roof
 - luggage compartment light left side
-

One Pedal Drive: possibility to use only one pedal to accelerate or brake. Just by lifting the pedal the driver can, on a short distance, slow the car all the way to standstill not having to use the brake pedal. This function is active when the engine is started and can easily be deactivated via a button on the steering wheel

Electric parking brake with Auto Hold (automatic brake at a standstill) and Hill Start Assist (assistance to start on a hill or slope) functions

Two Key Cards (NFC technology) to (un)lock or start the car

Tyre repair kit in the front load compartment

CLIMATE CONTROL

Single-zone electronic automatic climate control with CN95 pollen filter which reduces up to 98% of all the particles larger than 1 mikrometer in size. Air vents in the dashboard and under the front seats for the rear passengers

Interior climate preconditioning (cabin cooling or heating), including electrical heating of the front seats and the steering wheel (if present)

Rain sensor

INTERIOR

Upholstery made from partly biosourced Charcoal Nordico and Indigo textile in 100% recycled polyester

Denim inlays in the dashboard and the doors

Comfort manually six-way adjustable driver seat that features length fore-aft, height and recline adjustments

Comfort manually four-way adjustable front passenger seat that features length fore-aft and recline adjustments

Central console with:

- armrest between the front seats
 - sliding unit between the front seats that serves as a cupholder as well as storage box for a smartphone
 - open storage area on the floor
 - storage for up to two phones in the front edge of the central multi-storage below the centre display
 - centrally positioned glove box for smaller items below the centre display
-

Three-spoke sport black steering wheel with a flat top and bottom. Leather-free and wrapped in a synthetic material with a luxurious touch

Interior rear-view mirror with manual dimming

Front and rear premium black textile floor mats

Rear seats without central armrest. Folding back in two parts (60/40)



STANDARD EQUIPMENT CORE

VERSATILITY

Very spacious storage in the front door pockets

Removable rear storage box underneath the back of the armrest

Map storage pocket behind the front seats (not with Indigo-interior)

Front load compartment under the hood

Flexible load floor that can be placed in normal flat level or low level. The normal level creates a flat load floor when the rear seats are folded

Rigid, detachable luggage cover

4 load retainer eyelets and 2 shopping bag hooks in luggage compartment

12V power outlet in the luggage compartment

EXTERIOR

LED headlights with integrated T-shaped LED daytime running lights, manual level adjustment and Active High Beam

LED rear lights inclusive fog lights

Headlights and rear lamps can provide a welcome or farewell light sequence

Body-coloured closed front design that creates a bold EV look. With Volvo emblem located directly on the front cover

Nicely integrated air inlets at the outer ends of the bumper for improved aerodynamics

The lower body trim, bumper spoiler and lower door mouldings are in charcoal plastic with a grooved pattern

18" 5-aerospoke Silver rims and 225/55 R18 summer tyres

Power retractable and heated frameless exterior mirrors, with integrated LED indicator

Rear-view mirror caps and rear aerodynamic spoiler in body colour

NFC reader between the front and rear doors at the driver side

Preparation for mounting tow bar as accessory

Advanced chassis designed to give a comfortable and premium driving experience

RECHARGE

Heat pump (with Extended Range and Twin Motor Performance versions)

32 A charging cable, Mode 3, with Mennekes socket (for charging point), 5 metres

11 kW onboard charger (AC-DC converter)



TRIM LEVELS

PLUS	List price* € excl. VAT	List price* € incl. VAT BE	List price* € incl. VAT LU	Single Motor	Single Motor Extended Range	Twin Motor Performance
Includes the EX30 Core equipment supplemented by the specific Plus equipment	2.454,55	2.970	2.872	O	–	S
	2.933,88	3.550	3.433	–	O	S

*Supplement already included in the prices per trim level as shown in the table on page 3.

O = Option | S = Standard | – = Not available

Harman Kardon audio system with 9 speakers and 1,040 W 9 channel amplifier
- 1 mid-tweeter, 2 soft dome tweeters and 2 midrange integrated in a soundbar under the windscreen
- 2 full-range in the rear doors
- 1 air ventilated woofer under the windscreen
- 1 air ventilated subwoofer in the luggage compartment
Upholstery made from partly biosourced Charcoal Nordico and Indigo textile in 100% recycled polyester
Pilot Assist that can be activated up to 130 km/h and can include the following functions:
- look for lane markings and provide gentle steer assist to help keep the car centred in its lane
- Lane Change Assist: between 65 km/h and 130 km/h, when you activate your turn indicator, you just have to hold the steering wheel and the car can automatically change lane
- Distance to Truck Assist: between 50 and 130 km/h, when you overtake a truck, this function can steer your car automatically and utilise available space in the current lane to increase the side distance to the truck. The offset range is about 20 cm towards the centreline. After passing, the car can return to the centre of the lane.
If there are trucks on both sides of the car, this function can also help steer the car to a centred position between the trucks
Rear and Front Park Assist
Two-zone electronic automatic climate control system. Includes also the Air Quality System (AQS) to improve air quality inside the vehicle and an automatic air recirculation function. The driver and front passenger can also easily monitor in the centre display the levels of health-impairing fine particulate matters (PM 2.5) in the cabin
Power operated tailgate
Keyless Entry: passive (un)locking
Ambient illumination with indirect illumination on the instrument panel decors. This interior illumination is colour-coordinated with the unique colour theme of each interior design. Also possible to choose between five designed ambience themes
Central storage area on the floor between the front seats that can be closed so that a handbag can be placed on it
Smartphone pouch in the map storage pocket behind the front seats (not with Indigo-interior)
2 extra USB-C outlets behind the armrest
Wireless charging for smartphone in the front storage compartment underneath the glove box (electromagnetic induction technology)
1 remote control
Inner rear-view mirror with automatic dimming
Exterior mirrors with automatic dimming at driver side
LED entry lighting integrated in the exterior rear view mirrors
Onyx Black roof and mirror caps
Aerodynamic spoiler at the rear in Onyx Black
19" 5-aerospoke Black/Diamond Cut with 245/45 R19 summer tyre (for Extended Range and Twin Motor Performance versions)

ULTRA	List price* € excl. VAT	List price* € incl. VAT BE	List price* € incl. VAT LU	Single Motor	Single Motor Extended Range	Twin Motor Performance
Includes the EX30 Plus equipment supplemented by the specific Ultra equipment	2.603,31	3.150	3.046	–	–	O
	5.537,19	6.700	6.479	–	O	–

*Supplement already included in the prices per trim level as shown in the table on page 3.

O = Option | – = Not available

Fixed panoramic sunroof with IR coating that minimises glare and gives effective UV protection
Upholstery made from partly biosourced Charcoal Nordico and Indigo textile in 100% recycled polyester
Power-operated driver seat with memory function (settings including length fore-aft, height, tilt and recline)
Power-operated front passenger seat (settings including length fore-aft, height, tilt and recline)
Driver seat with four-way lumbar support adjustments
Exterior mirrors with memory function
22 kW onboard charger (AC-DC converter)
Park Pilot Assist: detects free parking slots on both sides of the car and - under the driver's supervision - parks itself automatically. If the system detects different free parking slots, the driver has to pick one of the selected slots shown on the central display. The Park Pilot Assist can simplify all the most common parking scenarios and can look for free parking slots up to 22 km/h
360° Park Assist Camera with 3D view:
- 1 front camera in the Volvo emblem (almost 180° view)
- 1 rear camera in the Volvo emblem (almost 180° view)
- 2 side cameras in the door mirrors
- 2 side sensors on each side of the car
- Split screen available with 360° birds-eye view, rear or front camera view and 3D view



INTERIOR

INDIGO		List price € excl. VAT	List price € incl. VAT BE	List price € incl. VAT LU	CORE	PLUS	ULTRA
PARTLY BIO-SOURCED NORDICO/TEXTILE IN 100% RECYCLED POLYESTER							
R310	Interior base colour: Charcoal	0,00	0	0	●	●	●
	Colour seats: Charcoal/Blue						
	Door pocket upholstery: Blue textile						
	Colour headlining: Charcoal						
	Dashboard and door inlays: Denim, with the top layer consisting of 50% denim fibers						

● = Included in trim level



INTERIOR

PINE		List price € excl. VAT	List price € incl. VAT BE	List price € incl. VAT LU	CORE	PLUS	ULTRA
PARTLY BIO-SOURCED NORDICO/WOOL BLEND PRODUCED WITH RESPECT FOR ANIMAL WELFARE							
R430	Interior base colour: Charcoal	504,13	610	590	-	O	O
	Colour seats: Metal Grey/Forest Green Melange						
	Door pocket upholstery: Forest Green Melange Wool Blend						
	Colour headlining: Charcoal						
	Dashboard and door inlays: Flax, with a top layer in woven flax, a natural renewable material from the linseed plant						

O = Option | - = Not available



INTERIOR

BREEZE*		List price € excl. VAT	List price € incl. VAT BE	List price € incl. VAT LU	CORE	PLUS	ULTRA
PARTLY BIO-SOURCED NORDICO/PIXEL KNIT TEXTILE IN 100% RECYCLED POLYESTER							
R540	Interior base colour: Charcoal Colour seats: Horizon Blue/Blue Door pocket upholstery: Horizon Blue Nordico Colour headlining: Charcoal Dashboard and door inlays: Particle, with the top layer made up of ground plastic waste from discarded PVC window frames and roller shutters	851,24	1.030	996	-	-	O

*Not with exterior colour Moss Yellow (625)

O = Option | - = Not available





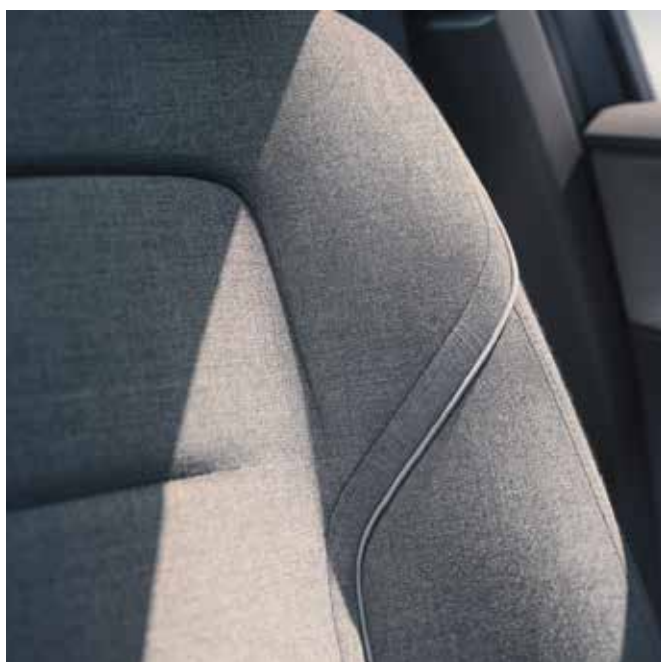

INTERIOR

	List price € excl. VAT	List price € incl. VAT BE	List price € incl. VAT LU	CORE	PLUS	ULTRA
WOOL BLEND PRODUCED WITH RESPECT FOR ANIMAL WELFARE						
R220 Interior base colour: Charcoal	1.049,59	1.270	1.228	-	-	O
Colour seats: Midnight Zink						
Door pocket upholstery: Midnight Zink Wool Blend						
Colour headlining: Charcoal						
Dashboard and door inlays: Flax, with a top layer in woven flax, a natural renewable material from the linseed plant						

O = Option | - = Not available



EXTERIOR

		List price € excl. VAT	List price € incl. VAT BE	List price € incl. VAT LU	CORE	PLUS	ULTRA
	626 Cloud Blue (not metallic)	0,00	0	0	●	●	●
	740 Vapour Grey Metallic	739,67	895	865	○	○	○
	707 Crystal White Pearl Metallic	739,67	895	865	○	○	○
	717 Onyx Black Metallic	739,67	895	865	○	○	○
	625 Moss Yellow (not metallic)	739,67	895	865	–	○	○

○ = Option | ● = Included in trim level | – = Not available

EXTERIOR

	List price € excl. VAT	List price € incl. VAT BE	List price € incl. VAT LU	CORE	PLUS	ULTRA
BODY-COLOURED ROOF AND EXTERIOR MIRRORS	0,00	0	0	●	-	-



ROOF AND EXTERIOR MIRRORS IN CONTRASTING ONYX BLACK METALLIC COLOUR	0,00	0	0	-	●	●
--	------	---	---	---	---	---



● = Included in trim level | - = Not available



TINTED WINDOWS

	List price € excl. VAT	List price € incl. VAT BE	List price € incl. VAT LU	CORE	PLUS	ULTRA
179 Privacy glass for rear windows and rear windscreen	330,58	400	387	O	O	O



O = Option

WHEELS

	List price € excl. VAT	List price € incl. VAT BE	List price € incl. VAT LU	CORE	PLUS	ULTRA		
18" ALLOY WHEELS								
	-	18" 5 aero spoke Silver Glossy Black aero inserts 225/55 R18 summer tyres	0,00	0	0	●	● SM /-	-
19" ALLOY WHEELS								
	-	19" 5 aero spoke Black/Diamond Cut Glossy Black aero inserts 245/45 R19 summer tyres	0,00	0	0	-	●/— SM	●
20" ALLOY WHEELS								
	200001	20" 5 aero spoke Black/Diamond Cut Multicolour aero inserts 245/40 R20 summer tyres	553,72	670	648	-	O/— SM	O

O = Option | ● = Included in trim level | - = Not available | SM = Only for Single Motor without Extended Range



OPTION PACKS

	List price € excl. VAT	List price € incl. VAT BE	List price € incl. VAT LU	CORE	PLUS	ULTRA
WINTER PACK						
Heated front seats	247,93	300	290			
Heated steering wheel	157,02	190	184			
Total value of equipment	404,96	490	474			
Diplo Pack advantage	-107,44	-130	-126			
200002 WINTER PACK	297,52	360	348	O	O	O

	List price € excl. VAT	List price € incl. VAT BE	List price € incl. VAT LU	CORE	PLUS	ULTRA
LUXURY SEAT PACK						
Power-operated driver seat with memory function (settings including length fore-aft, height, tilt and recline)	504,13	610	590			
Power-operated front passenger seat (settings including length fore-aft, height, tilt and recline)	355,37	430	416			
Driver seat with four-way lumbar support adjustments	123,97	150	145			
Exterior mirrors with memory function	33,06	40	39			
Total value of equipment	1.016,53	1.230	1.189			
Diplo Pack advantage	-272,73	-330	-319			
200004 LUXURY SEAT PACK	743,80	900	870	-	O	●

O = Option | ● = Included in trim level | - = Not available

ACCESSORY PACKS & ACCESSORIES

	List price € excl. VAT	List price € incl. VAT BE	List price € incl. VAT LU	EX30		List price € excl. VAT	List price € incl. VAT BE	List price € incl. VAT LU	EX30	
PROTECTION PACK										
A00112 Moulded plastic load compartment protection	128,10	155	150			A01437 Sunshade for panoramic roof	119,83	145	140	
A00492 Rubber floor mat front and rear	119,83	145	140			A00769 Wool neck cushion (Charcoal)	57,85	70	68	
A00217 Anti-theft wheel locks	57,85	70	68			A00106 Luggage net to be attached to load securing eyelets	57,85	70	68	
A01436 Bumper protection	140,50	170	164			A01247 Charging cable storage bag	57,85	70	68	
Total value of equipment	446,28	540	522			Total value of equipment	293,39	355	343	
Diplo Pack advantage	-90,91	-110	-106			Diplo Pack advantage	-33,06	-40	-39	
PA071 PROTECTION PACK	355,37	430	416	O		PA074 CONVENIENCE PACK	260,33	315	305	O

	List price € excl. VAT	List price € incl. VAT BE	List price € incl. VAT LU	EX30		List price € excl. VAT	List price € incl. VAT BE	List price € incl. VAT LU	EX30	
TRAVEL PACK										
A00101 Aluminium transversal roof bars	252,07	305	295			A00329 Child seat group 2/3 (15-36 kg) with Isofix anchorage	301,65	365	353	
A01240 Roofbox 'Travel 400', glossy black (400L, 175x87x46 cm)	665,29	805	778			A00096 Kick guard with storage pockets	57,85	70	68	
Total value of equipment	917,36	1.110	1.073			Total value of equipment	359,50	435	421	
Diplo Pack advantage	-90,91	-110	-106			Diplo Pack advantage	-33,06	-40	-39	
PA073 TRAVEL PACK	826,45	1.000	967	O		PA009 KIDS PACK	326,45	395	382	O

	List price € excl. VAT	List price € incl. VAT BE	List price € incl. VAT LU	EX30
TOW BAR				
A00463* Semi-automatic retractable tow bar with 13-pin outlet (Trailer Stability Assist system included)	950,41	1.150	1.112	O

* Accessories that affect the weight and aerodynamics of the car, and therefore also the electricity consumption and the range measured according to the WLTP.

O = Option

ACCESSORIES

	List price € excl. VAT	List price € incl. VAT BE	List price € incl. VAT LU	EX30
FULLY ELECTRIC				
A01230 Wallbox (until 22 kW) standard installation included*	1.938,02	2.345	2.267	O
A01150 Charging cord 1P 10A with Schuko socket (for domestic use), length 7 metres	363,64	440	425	O
A01354 Charging cord 3P 16A with CEE socket (for red industrial socket, 5 pins), length 6 metres	454,55	550	532	O
A01152 Charging cord 1P 16A with CEE socket (for blue industrial socket, 3 pins), length 7 metres	363,64	440	425	O
A01355 Charging cord 3P 16A mode 3 (type 2) with Mennekes socket (for charging point), length 6 metres	363,64	440	425	O
A01154 Charging cord 1P 16A mode 3 (type 2) with Mennekes socket (for charging point), length 7 metres	363,64	440	425	O
A01247 Charging cable storage bag	57,85	70	68	O
LUGGAGE COMPARTMENT				
A00112 Moulded plastic load compartment protection	128,10	155	150	O
A00119 Textile/plastic reversible load compartment floor mat	181,82	220	213	O
A00106 Luggage net to be attached to load securing eyelets	57,85	70	68	O
A00209 Nylon safety net behind the front seats	128,10	155	150	O
COMFORT				
A00492 Rubber floor mat front and rear	119,83	145	140	O
A00769 Wool neck cushion (Charcoal)	57,85	70	68	O
A01244 Wool cushion (Charcoal)	57,85	70	68	O
A01437 Sunshade for panoramic roof	119,83	145	140	O

* Indicative pricing for charging station with 1 fixed cable of 5m or socket and loadbalancing module. A standard installation includes an installation check by phone, wall or pole mounted (max 1 meter ground works), circuit breaker, fuses, 10m cable, 10m data cable, 10m tube, if necessary a supplementary small electricity cabinet, explanation, electric scheme, legal control. No demolition or excavation works included. Final price through tailor-made offer based on onsite visit.

O = Option



ACCESSORIES

		List price € excl. VAT	List price € incl. VAT BE	List price € incl. VAT LU	EX30
DESIGN					
A01436	Bumper cover	140,50	170	164	O
CHILD SAFETY					
A00096	Kick guard with storage pockets	57,85	70	68	O
A01000	Easy access rearward facing child seat i-Size with Isofix (0-18 kg)	628,10	760	735	O
A00328	Child seat group 1/2 (9-25 kg), rearward facing	363,64	440	425	O
A00379	Booster seat with detachable backrest in wool (15-36 kg)	231,40	280	271	O
A00329	Child seat group 2/3 (15-36 kg) with Isofix anchorage	301,65	365	353	O
VERSATILITY					
A01238	Folding bicycle holder on tow bar for two bicycles (Fix4Bike)	685,95	830	803	O
A01239	Bicycle holder on tow bar for three bicycles (Fix4Bike)	710,74	860	832	O
A00017	Adapter for extra bike (only with A01239)	128,10	155	150	O
A00101	Aluminium transversal roof bars	252,07	305	295	O
A01240	Roofbox 'Travel 400', glossy black (400L, 175x87x46 cm)	665,29	805	778	O
A01241	Roofbox 'Travel Active 500', glossy black (500L, 215x92x44 cm)	756,20	915	885	O
A01399	Roofbox 'Travel Premier 430', glossy black (430L, 223x94x30 cm), with LED lighting	962,81	1.165	1.126	O
A01143	Ski holder, sliding, to be fitted on load carrier	185,95	225	218	O
A00025	Bicycle holder with frame bracket (aluminium), to be fitted on load carrier (1 bicycle)	128,10	155	150	O
A00111	Lock kit - one key system	57,85	70	68	O

O = Option



ACCESSORIES

		List price € excl. VAT	List price € incl. VAT BE	List price € incl. VAT LU	EX30
SECURITY & PROTECTION					
A00604	Dog harness	119,83	145	140	O
A00217	Anti-theft wheel locks	57,85	70	68	O
A00164*	Front mud flaps	78,51	95	92	O
A00165*	Rear mud flaps	78,51	95	92	O
A00228	AutoSock (snow socks) (for 18" and 19" wheels)	107,44	130	126	O
A00227	Centrax snow chains (for 18" wheels)	342,98	415	401	O
WHEELS					
A01461	Set aero inserts White/Glossy Black for 20" rims	107,44	130	126	O
A01498	Winter wheels with 18" 5 aero spokes Silver rims and 225/55 R18 winter tyres	1.995,87	2.415	2.335	O
A01499	Winter wheels with 19" 5 aero spokes Black/Diamond Cut rims and 245/45 R19 winter tyres	2.388,43	2.890	2.794	O
A01500	Winter wheels with 20" 5 aero spokes Black/Diamond Cut rims and 245/40 R20 winter tyres	2.735,54	3.310	3.201	O

* Accessories that affect the weight and aerodynamics of the car, and therefore also the electricity consumption and the range measured according to the WLTP.

O = Option



EXTENDED SERVICES

VOLVO CAR EXTENDED WARRANTY

Drive with **peace of mind**

When you buy a Volvo, you are choosing top quality, safety and reliability. Not only because you are buying a quality vehicle, but also because your Volvo dealer offers you the best service.

An extension of the factory guarantee protects you against high costs in the event of unexpected defects. Thanks to the very comprehensive coverage, you can drive your Volvo for an additional 2 years without any worries when your Volvo manufacturer's warranty expires after 3 years.

Volvo Car Extended Warranty protects you against unforeseen repair costs, even after the Volvo manufacturer's warranty has expired.



GUARANTEED LIQUIDITY IN CASE OF REPAIRS

And extensive repair costs reimbursement outside the manufacturer's warranty

VALID ANYWHERE IN EUROPE

The extended warranty can also be transferred to the next owner

USE OF GENUINE VOLVO PARTS

And repaired by Volvo-trained personnel: your Volvo remains in optimal condition

	List price € excl. VAT	List price € incl. VAT BE	List price € incl. VAT LU	EX30
EXTENDED WARRANTY				
A00139 Volvo Car Extended Warranty + 1 year, limited to 200.000 km	371,90	450	435	O
A00140 Volvo Car Extended Warranty + 2 years, limited to 200.000 km	739,67	895	865	O

O = Option

DELIVERY PACK

VOLVO CAR DELIVERY PACK

Enjoy a **personalized delivery**

The delivery of a new car is a special moment. And Volvo makes this moment even more special. With the Delivery Pack, we provide a personalized unveiling of your new Volvo followed by a detailed explanation during and after delivery. Of course, we make sure your car is fully roadworthy and equipped to enjoy the Volvo experience right away.



- 5 safety vests
- fire extinguisher
- warning triangle
- front numberplate

- car charged to at least 80%
- detailed explanation of all car features
- Volvo EX30 app setup

- car delivered under cover
- 1 hour follow-up meeting for all your questions after delivery

	List price € excl. VAT	List price € incl. VAT BE	List price € incl. VAT LU
DELIVERY PACK			
DELIV01 Volvo Car Delivery Pack	371,90	450	435

TECHNICAL SPECIFICATIONS

ENGINE	Single Motor	Single Motor Extended Range	Twin Motor Performance
Engine code	E400V10 (EM)	E400V18 (EL)	E400V14 (EK)
Engine type	One electric motor	One electric motor	Two electric motors
Electric engine battery	Lithium-ion (LFP)	Lithium-ion (NMC)	Lithium-ion (NMC)
Battery energy capacity (nominal) kWh	51	69	69
Battery energy capacity (usable) kWh	49	65	65
Max. capacity kW/hp (combined)	200/272	200/272	315/428
Max. power kW/hp (rear engine)	200/272	200/272	200/272
Max. power kW/hp (front engine)	-	-	115/156
Max. torque Nm (rear engine)	343	343	343
Max. torque Nm (front engine)	-	-	200
Emissions standard	EURO 6e	EURO 6e	EURO 6e
TRANSMISSION			
Motricity	RWD (rear wheel drive)	RWD (rear wheel drive)	AWD (all wheel drive)
Gearbox	Single-speed	Single-speed	Single-speed
PERFORMANCES			
Acceleration 0-100 km/h (sec)	5,7	5,3	3,6
Top speed (km/h)	180	180	180
RECHARGE			
Max AC charging (kW)	11	11/22 (Ultra)	11/22 (Ultra)
Max DC charging (kW)	134	153	153
Charge time, 1-phase, AC, from 0 to 100% (32A/16A/10A) 230V (hours)	9/18/28	11/23/39	11/23/39
Charge time, 3-phase, AC, from 0 to 100% (16A/10A) (hours)	6/9	8/12	8/12
Charge time, 3-phase, AC, from 0 to 100% (32A) (hours)	-	-/4 (Ultra)	-/4 (Ultra)
Charge time (fast charging), DC, from 10 to 80% (150 kW/50 kW) (min.)	26/48	-	-
Charge time (fast charging), DC, from 10 to 80% (175 kW/50 kW) (min.)	-	26,5/56	26,5/56
CONSUMPTION AND RANGE ACCORDING TO WLTP			
Electric power consumption min. (combined) kWh/100km	17,1-17,8	17,0 - 17,5	17,5 - 18,0
Electric range max. (combined) km	337-324	476 - 462	450 - 445
WEIGHTS AND MEASURES			
Min. curb weight (kg)	1.765	1.775	1.885
Running order weight (kg)	1.840	1.850	1.960
Max. total weight (kg)	2.210	2.240	2.335
Max. weight braked/unbraked trailer (kg)	1.000/750	1.600/750	1.600/750
Max. roof load capacity (kg)	75	75	75
Largest load volume with bench seat back folded down ISO V214-1 (incl. V209) (liters)	1.000	1.000	1.000
Largest volume load compartment ISO V214-2 (incl. V209) (liters)	400	400	400
Volume load compartment under luggage cover ISO V211-2 (incl. V209) (liters)	318	318	318
Volume under load compartment floor ISO V209 (liters)	61	61	61

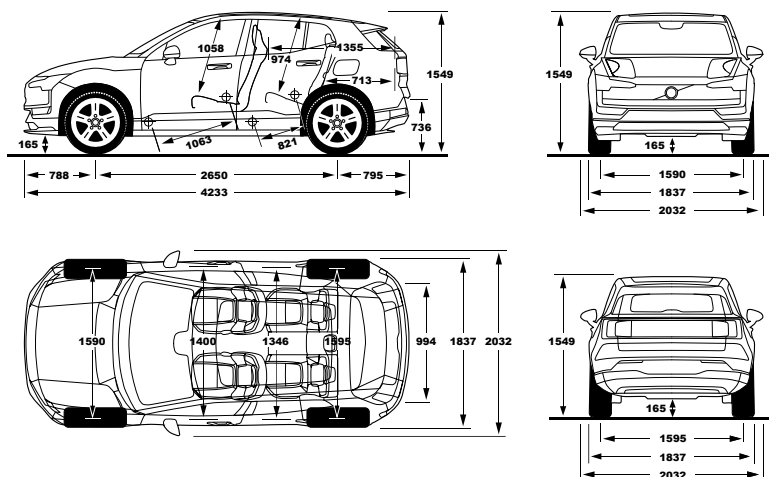

DIMENSIONS	
EXTERIOR	
Length x width x height (driver included)	423,3 x 183,8 x 154,9 cm
Wheelbase	265,0 cm
Front track (with 18" rims/19"/20")	159,0 cm
Rear track (with 18" rims/19"/20")	159,5 cm
Turning circle between curbs	10,7 m
Ground clearance (driver included)/foraging depth	17,1/50,0 cm
INTERIOR	
Headroom with sunroof front/rear	101,8/97,4 cm
Headroom without sunroof front/rear	98,0/93,5 cm
Shoulder room front/rear	140,0/134,6 cm
Leg room front/rear	106,3/82,1 cm
Length luggage compartment rear seats-tailgate	72,0 cm
Length luggage compartment front seats-tailgate	146,0 cm
Height luggage compartment	62,3 cm
Lifting height	73,6 cm
Width luggage compartment between wheel arches	99,4 cm
Min./max. width tailgate opening	89,5/101,9 cm

VOLVO CARE OFFER FOR VOLVO FULLY ELECTRIC

The Volvo Care Offer 'Service & Maintenance for Volvo Fully Electric' is included* with the purchase of any new, all-electric Volvo. This page describes the services and parts included in the maintenance and service programme for these vehicles.

The Volvo Care Offer 'Service & Maintenance for Volvo Fully Electric' is valid for a period of **5 years from the date of delivery or 150.000 km** (whichever comes first). The vehicle owner can have the periodic maintenance of his/her Volvo Fully Electric carried out at the prescribed service intervals in any authorised Volvo workshop in Belgium or the Grand Duchy of Luxembourg.

Our in-house trained Volvo technicians maintain the vehicle and keep it in top condition. They also carry out a health check and verify whether the vehicle is equipped with the latest software.

The detailed terms and conditions applicable to this Volvo Care Offer 'Service & Maintenance for Volvo Fully Electric', including restrictions, will be handed over to the first owner of the vehicle by the Volvo retailer who delivers the vehicle. These will remain valid for the stated duration and mileage, even if there has been a change in ownership.

The Volvo Care Offer 'Service & Maintenance for Volvo Fully Electric' applies to the vehicle specified on page 3 in this price list, and for a period of **5 years from the date of delivery or 150.000 km** (whichever comes first). The Volvo Care Offer 'Service & Maintenance for Volvo Fully Electric' covers periodic maintenance services, every 24 months or every 30.000 km (whichever comes first), and includes replacement of the wear and tear parts listed below.

- Volvo Car Service at scheduled service intervals
 - health check
 - air filter replacement
 - tyre sealant replacement in accordance with the prescribed interval
 - cleaning of the sensors and cameras for the safety systems under the windscreen
 - software updates
- **Includes** replacement of the following wear and tear parts: brake pads and discs (when required) and windscreen wiper blades (1x per year).
 - **Excludes** replacement of wear and tear parts not explicitly mentioned above.

* Volvo vehicles with specific service programmes (such as taxis, police vehicles or vehicles with other specific purposes) are not eligible for the Volvo Care Offer 'Service & Maintenance for Volvo Fully Electric' described above.

The 'Volvo Car Service' maintenance programme may be amended by Volvo Cars, provided that such amendment will not affect the application of the Volvo Cars warranty or affect the vehicle owner's rights under the Volvo Care Offer.

The inclusion of wear and tear parts in the Volvo Care Offer 'Service & Maintenance for Volvo Fully Electric' does not affect the reference to 'wear and tear' in the Service and Warranty Booklet.

The Volvo Care Offer 'Service & Maintenance for Volvo Fully Electric' is subject to the terms and conditions regarding service and maintenance. Should you have any questions about this, please do not hesitate to contact our Volvo retailers.

VOLVO CARE OFFER GENERAL TERMS AND CONDITIONS 'SERVICE & MAINTENANCE FOR VOLVO FULLY ELECTRIC'

1. Application of the conditions

These Volvo Care Offer terms and conditions 'Service & Maintenance for Volvo Fully Electric' apply to new, all-electric Volvo vehicles. These terms and conditions form part of the purchase contract for the vehicle. Regardless of whether the vehicle is purchased from a Volvo Car Corporation entity or from a Volvo retailer, the Volvo National Sales Company or Volvo's importer in the country of first purchase is responsible for this service programme.

2. Validity of the Volvo Care Offer 'Service & Maintenance for Volvo Fully Electric'

- The Volvo Care Offer 'Service & Maintenance for Volvo Fully Electric' is valid for a defined limited period of time, as previously stated and includes, where applicable, defined wear and tear parts of the vehicle, as previously specified. Any work carried out that is not covered by the Volvo Care Offer 'Service & Maintenance for Volvo Fully Electric' will remain the responsibility of the customer. When all required work has been carried out or when the limited validity period has expired, the Volvo Care Offer 'Service & Maintenance for Volvo Fully Electric' will end. The maintenance programme will also be considered terminated if maintenance should have been carried out in accordance with the prescribed maintenance intervals (as stated in the owner's manual and the Service and Warranty Booklet for the vehicle) but the vehicle has not been presented to an authorised Volvo workshop to carry out the Volvo Car Service.
- The Volvo Care Offer 'Service & Maintenance for Volvo Fully Electric' is linked to the market in which it was originally sold. The periodic maintenance of the vehicle according to the prescribed service intervals can only be carried out in the authorised Volvo workshops within that market.
- Volvo Cars has the right to terminate the Volvo Care Offer 'Service & Maintenance for Volvo Fully Electric' with immediate effect should the conditions of Volvo Cars' operations in the relevant market change significantly due to circumstances outside of Volvo Cars' control and should these circumstances make it very difficult for Volvo Cars to carry out the Volvo Care Offer 'Service & Maintenance for Volvo Fully Electric'. Both parties have the right to terminate the Volvo Care Offer 'Service & Maintenance for Volvo Fully Electric' with immediate effect should the other party be in serious or repeated breach of its obligations under these terms and conditions.

3. Owner obligations

Periodic maintenance of the vehicle must be carried out according to Volvo Cars' recommendations. Volvo Car Service in accordance with the prescribed service

intervals, depends on time and annual mileage and may occur at different time intervals. The validity of the Volvo Care Offer 'Service & Maintenance for Volvo Fully Electric' further requires that the vehicle owner:

- Drives, maintains and manages the vehicle in accordance with the instructions in the vehicle owner's manual (extended version can be found at volvocars.com) and in the Service and Warranty Booklet (included in the vehicle documents).
- Conducts routine checks of the fluid levels in the vehicle between recommended service intervals and, if necessary, fills up at its own expense.
- Delivers the vehicle, at its own expense, to an authorised Volvo workshop for maintenance in accordance with the service intervals specified in the owner's manual and the vehicle Service and Warranty Booklet.

4. Transfer of the Volvo Care Offer 'Service & Maintenance for Volvo Fully Electric'

If the vehicle is sold or otherwise transferred to a new owner, the Volvo Care Offer 'Service & Maintenance for Volvo Fully Electric' follows the vehicle. All remaining services in the maintenance programme can then be used by the new owner in accordance with these terms and conditions.

5. Disclaimer

This maintenance programme Volvo Care Offer 'Service & Maintenance for Volvo Fully Electric' does not include any obligation on the part of any Volvo retailer or Volvo Cars to reimburse the vehicle owner in any way for costs, loss of income, loss of time or any other damage caused by the vehicle being temporarily handed over to the workshop for maintenance, or by the vehicle not being able to be used during the period in which it has been handed over to the workshop for scheduled maintenance. Nothing in these terms and conditions shall exclude, limit or modify any warranty, guarantee, term or condition, right or remedy implied or imposed by applicable law which cannot be legally excluded or limited.

6. Applicable Laws and Disputes

In the event of any dispute concerning the interpretation or application of the Volvo Care Offer 'Service & Maintenance for Volvo Fully Electric', the parties shall seek to resolve this by mutual agreement. The Volvo Care Offer 'Service & Maintenance for Volvo Fully Electric' shall be governed by the laws of the country of first purchase of the vehicle and in the event of any dispute the competent national courts shall have jurisdiction.



Some of the information in this brochure may be incorrect due to changes to the product specifications introduced after the brochure was published, such as consumption figures. Volvo Car Belux reserves the right to make changes to the prices, colours, materials, specifications and models at any time without prior notice. The images shown are for information purposes only and may differ from the actual product. Certain equipment, options or accessories described or shown are available at an additional cost. All list prices in this brochure are recommended resale prices. VAT applicable is 21% for Belgium and 17% for the Grand Duchy of Luxembourg. Ask your Volvo distributor for the latest information before ordering.

The prices for accessories always include fitting (unless otherwise specified) and (where applicable) Recupel (for Belgium) or Ecotrel (for the Grand Duchy of Luxembourg). Recommended prices for wheel kits (composed of 4 complete wheels with rims and tyres) always include environmental contribution (Recytyre for Belgium), but without fitting and software update (if needed).

Environmental contribution included.

A 4-year data subscription for use of Google services and all apps is included in the retail price of the car. After that period, a paid extension of the data subscription will be available or you can share your data via your smartphone.

Environmental information [Royal Decree 19/03/2004]: all self-respecting Volvo drivers put safety first.
R.P.: Florent Andrieu - Registered address/head office: Volvo Car Belgium nv, Avenue John Kennedy 25,
B-9000 Ghent - Place of business: Volvo Car Belux - VAT no.: BE 0420.383.548

V O L V O

VOLVOCARS.BE/LU
2024 - V03.MY25

